

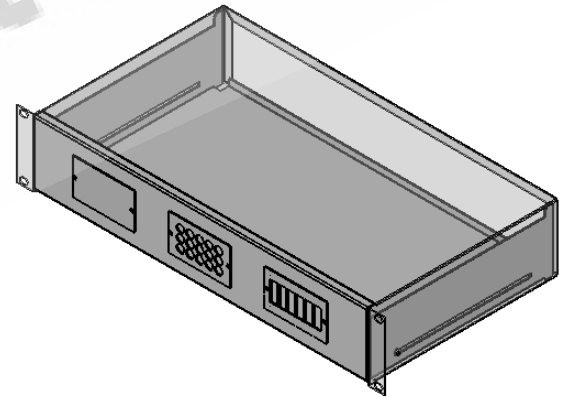

PROPRIETARY AND CONFIDENTIAL
 ALL INFORMATION CONTAINED IN THIS DRAWING IS THE SOLE PROPERTY OF OLIVETEL S.A.
 ANY REPRODUCTION IN PART OR AS A WHOLE WITHOUT THE WRITTEN PERMISSION OF
 OLIVETEL S.A. IS PROHIBITED.
 PROPRIETARY DATA; ALL RIGHTS RESERVED.

PROPRIEDADE E CONFIDENCIALIDADE
 TODA A INFORMAÇÃO CONTEIDA NESTE DESENHO É EXCLUSIVA PROPRIEDADE DA OLIVETEL S.A.
 QUALQUER REPRODUÇÃO PARCIAL OU TOTAL SEM O CONSENTIMENTO ESCRITO DA
 OLIVETEL S.A. É PROIBIDA.
 COMUNICADO COMO SEGREDO EMPRESARIAL; RESERVADOS TODOS OS DIREITOS.

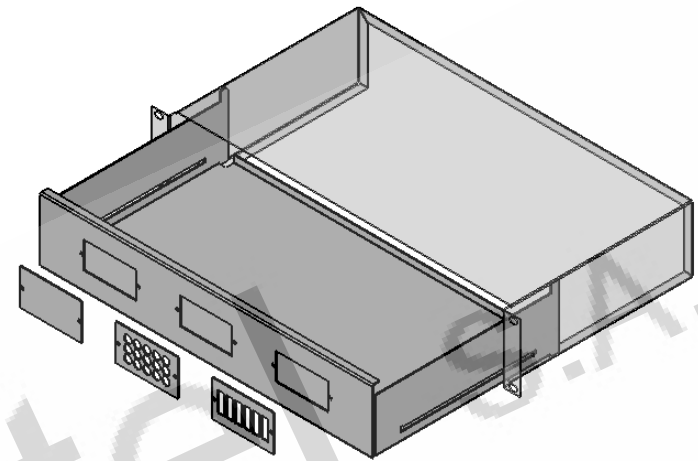
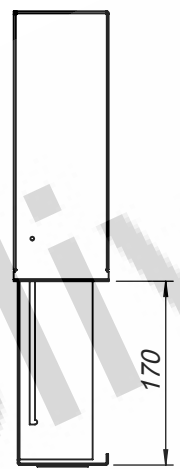
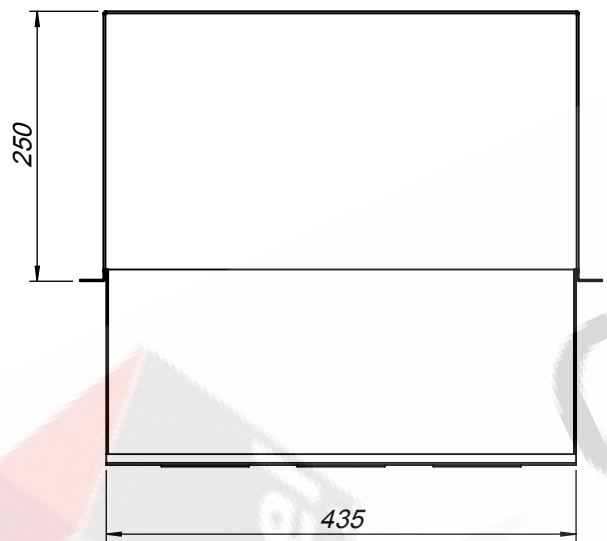
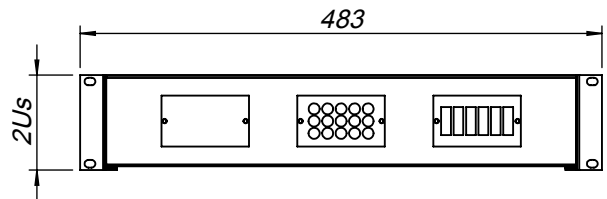
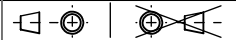

 olivetel s.A. Departamento de Projecto Project Department Projekt Abteilung		PROJECTO: Project/Projekt: GAV.INIV.2		MATERIAL: Werkstoff: Chapa Aço carbono ST_12 - Esp. 1.5mm Tratamento de Superfície Surface Finishing/Oberflaeche: Pintura electrostática Ral 7035 80/120µ (Interior)	
ESCALA: 1:50 Todas as dimensões em mm Units / Einheit: mm		DESIGNAÇÃO: Designation/Benennung: Vistas Gerais		DESENHO Nº: Drawing Nº/Z. Nr: Gav.Univ.2U	
PROJECTADO: Design by: Projekt:		FORMATO: Size/Format: A4		TOLERÂNCIAS GERAIS: Tolerances: Allgemeintoleranz: DIN 7168-m	
DESENHADO: Drawn by: FM Bearb.: 18-02-2015				PESO: Weight: 3882.45 gr. Gewicht:	
OBSERVAÇÕES: Comments: Bemerkung:					