

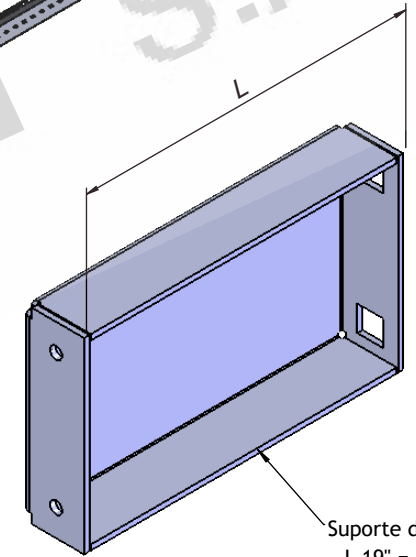

PROPRIETARY AND CONFIDENTIAL
 CONTAINED IN THIS DRAWING IS THE SOLE PROPERTY OF OLIVETEL S.A.
 ANY REPRODUCTION IN PART OR AS A WHOLE WITHOUT THE WRITTEN PERMISSION OF
 OLIVETEL S.A. IS PROHIBITED.
 PROPRIETARY DATA; ALL RIGHTS RESERVED.

PROPRIEDADE E CONFIDENCIALIDADE
 ESTE DESENHO É EXCLUSIVA PROPRIEDADE DA OLIVETEL S.A.
 QUALQUER REPRODUÇÃO PARCIAL OU TOTAL SEM O CONSENTIMENTO ESCRITO DA
 OLIVETEL S.A. É PROIBIDA.
 COMUNICADO COMO SEGREDO EMPRESARIAL; RESERVADOS TODOS OS DIREITOS.

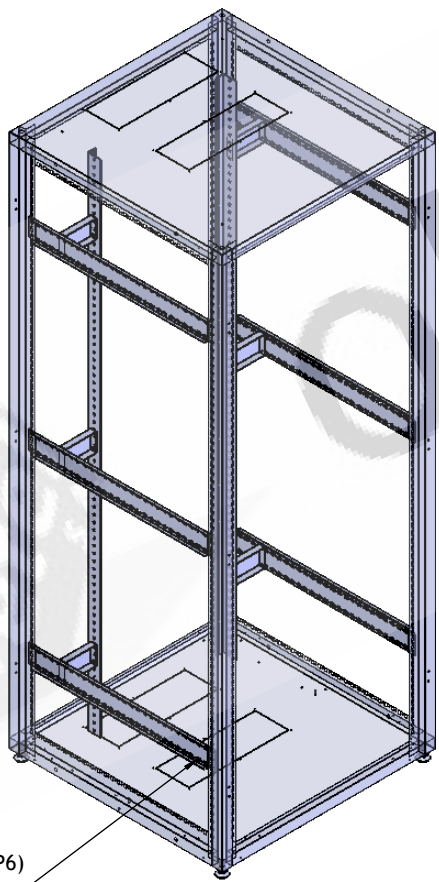
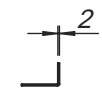
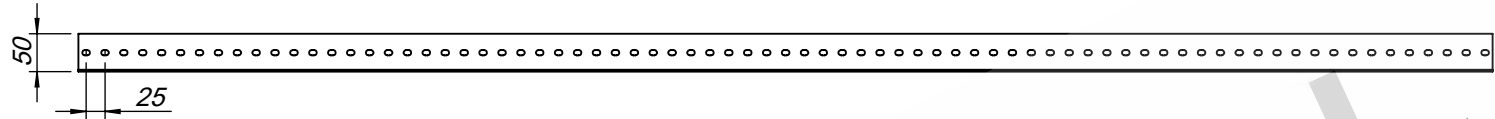
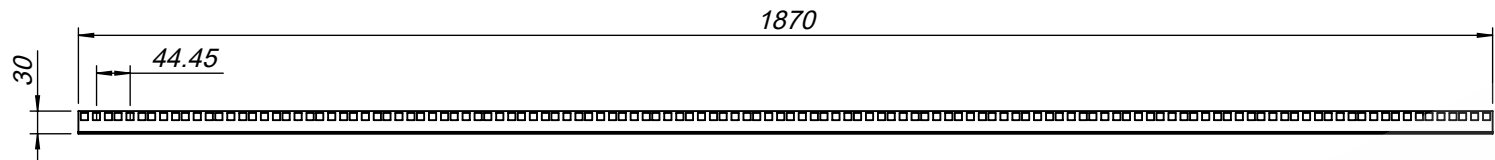

Suporte de Rack (6x)
 L 19" = 119.5 mm

(6x) 112.EA.TRAV.S.500mm (P6)
 (6x) 112.EA.TRAV.S.700mm (P8)

 olivetel s.a. Departamento de Projecto Project Department Projekt Abteilung www.olivetel.pt	PROJECTO: Project/Projekt:	MATERIAL: Werkstoff:								
	EA	Chapa Aço Galvanizado Galvanized sheet steel								
ESCALA: 1:20 Todas as dimensões em mm Units / Einheit: mm	DESIGNAÇÃO: Designation/Benennung:	Tratamento de Superfície Surface Finishing/Oberflaeche:								
<table border="1"> <thead> <tr> <th>NOME</th> <th>DATA</th> </tr> <tr> <th>Name</th> <th>Date/Datum</th> </tr> </thead> <tbody> <tr> <td>PROJECTADO: Design by: Projekt:</td> <td>FM 2017-02-16</td> </tr> <tr> <td>DESENHADO: Drawn by: Bearb.:</td> <td>TA 2017-07-21</td> </tr> </tbody> </table>	NOME	DATA	Name	Date/Datum	PROJECTADO: Design by: Projekt:	FM 2017-02-16	DESENHADO: Drawn by: Bearb.:	TA 2017-07-21	Vistas Gerais Drawing views	DESENHO Nº: Drawing Nº./Z. Nr.:
NOME	DATA									
Name	Date/Datum									
PROJECTADO: Design by: Projekt:	FM 2017-02-16									
DESENHADO: Drawn by: Bearb.:	TA 2017-07-21									
FORMATO: Size/Format: A4		112.EA.RACK.19.2E TOLERÂNCIAS GERAIS: Tolerances: Allgemeintoleranz: DIN 7168-m								
		PESO: 2220.358 gr. Weight: Gewicht:								
		OBSERVAÇÕES: Comments: Bemerkung:								