

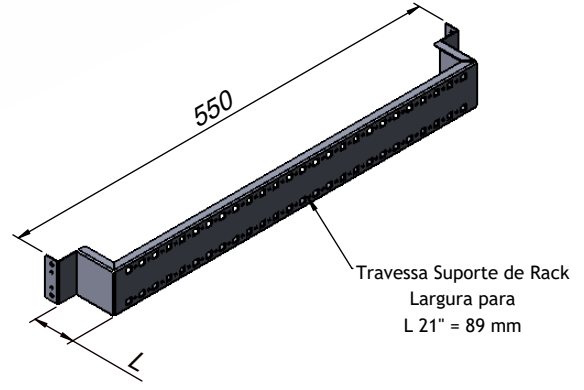

PROPRIETARY AND CONFIDENTIAL  
 CONTAINED IN THIS DRAWING IS THE SOLE PROPERTY OF OLIVETEL S.A.  
 ANY REPRODUCTION IN PART OR AS A WHOLE WITHOUT THE WRITTEN PERMISSION OF  
 OLIVETEL S.A. IS PROHIBITED.  
 PROPRIETARY DATA; ALL RIGHTS RESERVED.

PROPRIEDADE E CONFIDENCIALIDADE  
 O CONTEÚDO CONTEÚDO NESTE DESENHO É EXCLUSIVA PROPRIEDADE DA OLIVETEL S.A.  
 QUALQUER REPRODUÇÃO PARCIAL OU TOTAL SEM O CONSENTIMENTO ESCRITO DA  
 OLIVETEL S.A. É PROIBIDA.  
 COMUNICADO COMO SEGREDO EMPRESARIAL; RESERVADOS TODOS OS DIREITOS.

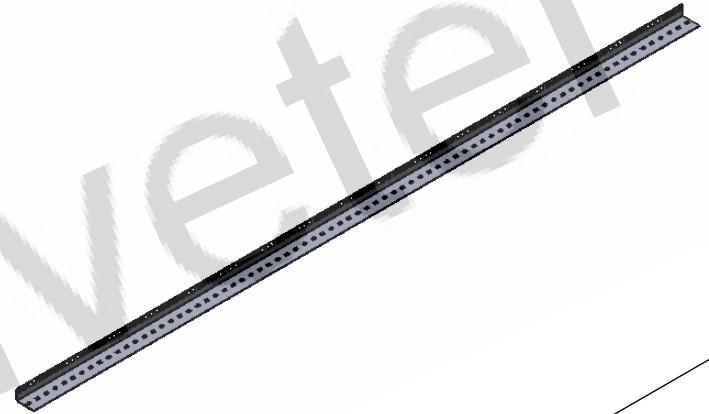
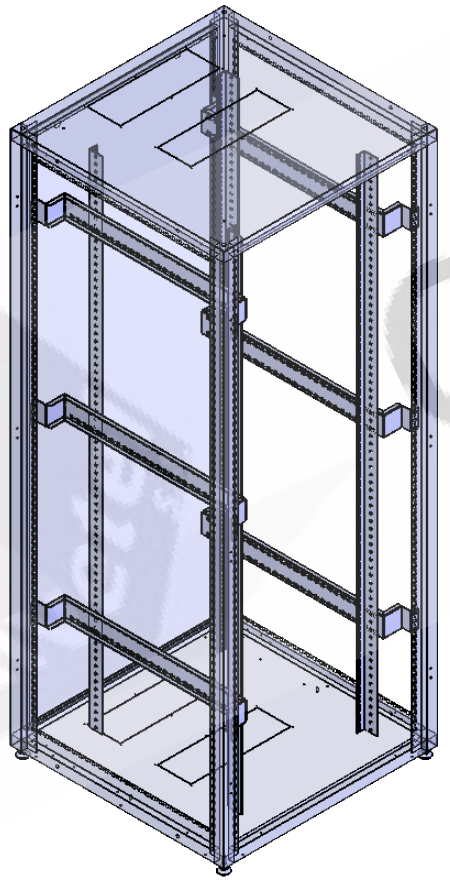
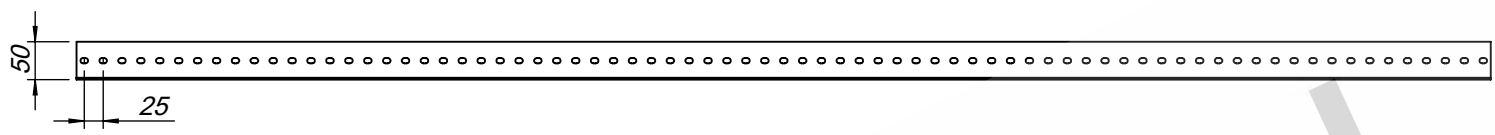
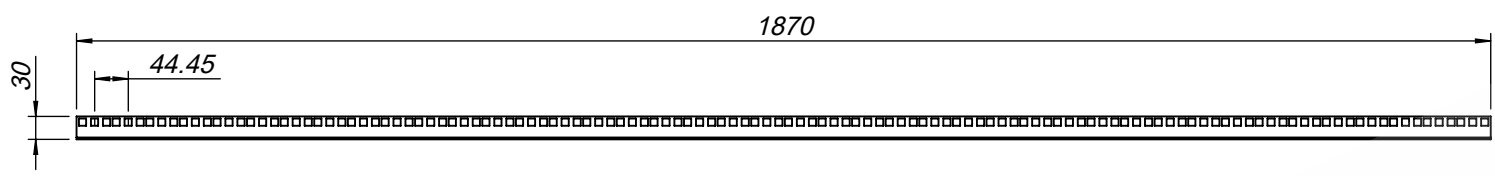

 <b>olivetel</b> s.a. Departamento de Projecto Project Department Projekt Abteilung	PROJECTO: Project/Projekt:	MATERIAL: Werkstoff:										
	EA	Chapa Aço Galvanizado Galvanized sheet steel										
ESCALA: 1:20 Todas as dimensões em mm Units / Einheit: mm	DESIGNAÇÃO: Designation/Benennung:	Tratamento de Superfície Surface Finishing/Oberflaeche:										
<table border="1"> <thead> <tr> <th>NOME</th> <th>DATA</th> </tr> <tr> <th>Name</th> <th>Date/Datum</th> </tr> </thead> <tbody> <tr> <td>PROJECTADO: Design by:</td> <td>2017-07-28</td> </tr> <tr> <td>DESENHADO: Drawn by:</td> <td>FM 2017-07-28</td> </tr> <tr> <td>BEAR.: Bearb.:</td> <td></td> </tr> </tbody> </table>	NOME	DATA	Name	Date/Datum	PROJECTADO: Design by:	2017-07-28	DESENHADO: Drawn by:	FM 2017-07-28	BEAR.: Bearb.:		Vistas Gerais Drawing views	DESENHO Nº: Drawing Nº./Z. Nr.:
NOME	DATA											
Name	Date/Datum											
PROJECTADO: Design by:	2017-07-28											
DESENHADO: Drawn by:	FM 2017-07-28											
BEAR.: Bearb.:												
FORMATO: Size/Format: A4		112.EA.PRACK21.2E6										
		TOLERÂNCIAS GERAIS: Tolerances: Allgemeintoleranz: DIN 7168-m										
		PESO: Weight: 2220.358 gr. Gewicht:										
		OBSERVAÇÕES: Comments: Bemerkung:										